

# **L-MAG Electromagnetic Flow meter Standard MODBUS Communication Protocol**

**(Version number: LMAGMODRTUV77)**

**2012-10-1**

## 目录

1. Introduction.....	- 3 -
2. L-mag network structure and wiring.....	- 3 -
3. RTU frame format of modbus protocol.....	- 4 -
1) Master order frame structure .....	- 4 -
2) Slave response frame structure .....	- 4 -
4. Code definition of MODBUS protocol order .....	- 5 -
5. MODBUS register definition of electromagnetic flowmeter .....	- 6 -
1) MODBUS register definition of electromagnetic flowmeter.....	- 6 -
2) PLC address set illustration.....	- 6 -
6. Communication data analysis .....	- 8 -
1) Read instantaneous flow.....	- 8 -
2) Read instantaneous velocity .....	- 9 -
3) Read cumulative flow.....	- 10 -
4) Read instantaneous flow unit .....	- 11 -
5) Read the unit of the total amount of flow .....	- 11 -
6) Read alarm status.....	- 11 -
7. Application examples .....	- 12 -
1) MODBUS example program with C .....	- 12 -
2) Communication example of MODBUS debugging software MODUBS poll.....	- 14
-	-
3) Communication example of MODBUS debugging software modscan32..	-15-
4) Communication example of “KingView 6.53”.....	- 18 -
5) Communication example of “力控 6.1”.....	- 22 -
6) MCGS communication example .....	- 25 -

**Remark:** The routine of this protocol’s application example only provide reference. Some parameters in the routine are different from the address definition of MODBUS

register. Please subject to the address definition of MODBUS register.

## 1. Introduction

L-mag electromagnetic flowmeter has the standard MODBUS communication interface supporting baud rate 1200, 2400, 4800, 9600, 19200. Through MODBUS communication network, host can collect instantaneous flow, instantaneous velocity and accumulative flow.

L-mag electromagnetic flowmeter uses serial port parameters: 1 start bit, 8 data bits, 1 stop bit, none parity bit.

L-mag electromagnetic flowmeter MODBUS communication port uses electric isolation mode in physical structure. The isolation voltage is 1500V and it owns ESD protection. Thus it can overcome various interferences from industrial scene to ensure the reliability service of communication network.

## 2. L-mag network structure and wiring

L-mag electromagnetic flowmeter's standard MODBUS communication network is bus network. It can support 1-99 electromagnetic flowmeters to network organization. As the farthest electromagnetic flowmeter in the network, it usually needs a 120  $\Omega$  matched termination resistor to connect the two ports of communication wire in parallel. The standard communication connection media is shielded twisted pair.

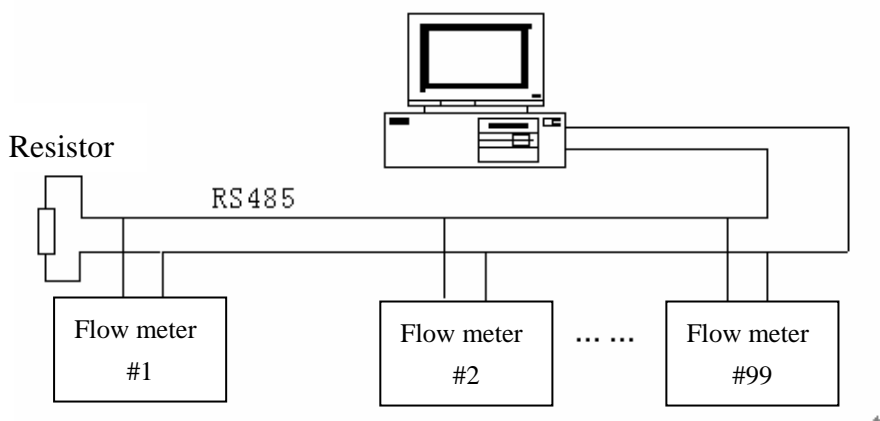

Figure-1 Electromagnetic flowmeter network structure

L-mag electromagnetic flowmeter communication wiring is shown in electromagnetic flowmeter in detail.

### 3. RTU frame format of modbus protocol

MODBUS protocol is a kind of master-slave communication. Every communication is started from master and slave responds master' order through passing back data.

L-mag electromagnetic flowmeter uses the MODBUS RTU frame format (hexadecimal format). Its frame format is shown in figure2.

1) Master order frame structure

Start	Device address	Function code	Register address	Register length	CRC	Stop
T1-T2-T3-T4	8Bits	8Bits	16Bits	16Bits	16Bits	T1-T2-T3-T4

Figure-2 Master RTU message frame

2) Slave response frame structure

Start	Device address	Function code	Data	CRC	Stop
T1-T2-T3-T4	8Bits	8Bits	n 8Bits	16Bits	T1-T2-T3-T4

Figure-3 Slave RTU message frame

**Remark:**

- T1-T2-T3-T4 is start or stop frame. MODBUS protocol sets that every two frames must have 3.5 char delay at least. It is shown in figure-4.

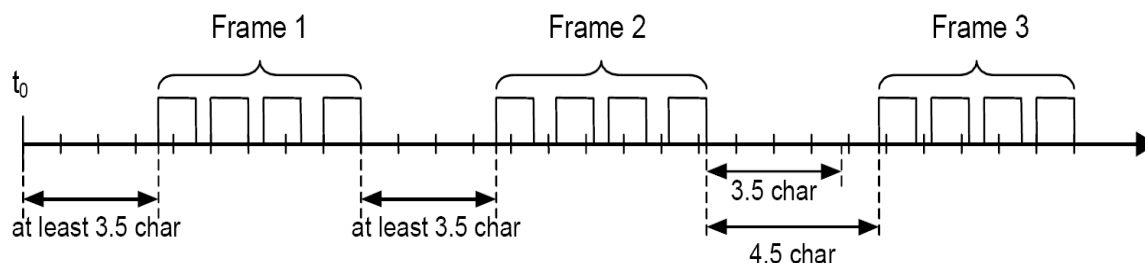

Figure-4 MODBUS frame interval

- Device address: It is electromagnetic flowmeter's communication address. It couldn't have two same address in a network.

- Function code: It is set by MODBUS protocol. L-mag electromagnetic flowmeter uses the function code 4 which realize the collecting function through reading input register.
- Register address and register number: The start address of register which restore data. Register number is the number that is used to store data.
- Slave response data: Byte number and N bytes data.

They are all shown in MODBUS protocol in detail.

#### 4. Code definition of MODBUS protocol order

Table-1

Function code	name	function
01	Read coil status	reservation
02	Read input status	reservation
03	Read holding registers	reservation
04	Read input register	read Electromagnetic Flowmeter real-time information
05	Strong set single coil	reservation
06	Preset single register	reservation
07	read abnormal status	reservation
08	Loopback diagnostic check	reservation
09	Program (only used for 484)	reservation
10	Control exercise (only used for 484)	reservation
11	Read events count	reservation
12	Read communication events record	reservation
13	Program (184/384 484 584)	reservation
14	Inquire (184/384 484 584)	reservation
15	Strong multi-coil set	reservation

## 5. MODBUS register definition of electromagnetic flowmeter

### 1) MODBUS register definition of electromagnetic flowmeter

Table-2

Protocol Addresses (Decimal)	Protocol Addresses (HEX)	Data format	Resister definition
4112	0x1010	Float Inverse	Instantaneous flow float representation
4114	0x1012	Float Inverse	Instantaneous velocity float representation
4116	0x1014	Float Inverse	Float representation of the flow percentage (reservation for battery-powered)
4118	0x1016	Float Inverse	Floating representation of fluid conductivity ratio
4120	0x1018	Long Inverse	Integer part of the cumulative positive value
4122	0x101A	Float Inverse	Decimal part of the cumulative positive value
4124	0x101C	Long Inverse	Integer part of the cumulative negative value
4126	0x101E	Float Inverse	Decimal part of the cumulative negative value
4128	0x1020	Unsigned short	Instantaneous flow unit (table-3)
4129	0x1021	Unsigned short	Cumulative total units (table-4 or table-5)
4130	0x1022	Unsigned short	Upper limit alarm
4131	0x1023	Unsigned short	Lower limit alarm
4132	0x1024	Unsigned short	Empty pipe alarm
4133	0x1025	Unsigned short	System alarm

### 2) PLC address set illustration

If there isn't function code setting options when we configure PLC, you should

add 3 in front of register address when you use function code 04. If PLC register address's basic address is from 1, you should add 1 to original address when configuring register address.

**Example:** L-mag electromagnetic flowmeter MODBUS register address is 4112(0x1010) and MODBUS function code is 4. So PLC register address is 34113.

The detailed configuration is seen in example chapter 2.

**3) Address configuration illustration of KingView software**

There isn't option of configuring function code. Different drivers have different configuration methods.

Take PLC- Modicon-MODBUS (RTU) driver for a example. You should add 8 in front of register address when using function code 04. KingView register address's basic address is 1, so the original address should be added 1 when configuring KingView register address.

L-mag electromagnetic flowmeter MODBUS register address is 4112(0x1010) and MODBUS function code is 4. So PLC register address is 84113.

The detailed configuration is seen in example chapter 4.

**4) Illustration of data's meaning**

- Float format:

L-mag electromagnetic flowmeter MODBUS uses IEEE754 which is 32 bits float format. Its structure is shown as follows: (take Instantaneous flow for a example)

0X1010 (34113)		0x1011 (34114)	
BYTE1	BYTE2	BYTE3	BYTE4
S EEEEEEE	E MMMMMMM	MMMMMMMM	MMMMMMMM

S- Mantissa symbol; 1=negative, 0=positive.

E- Exponent; expressed by the difference with decimal number 127.

M- Mantissa; low 23 bits and the decimal part.

When not all of the E is "0" and "1", the conversion formula between float and the decimal number is:

$$V = (-1)^S 2^{(E-127)} (1 + M)$$



● Instantaneous flow unit

Code	Unit	Code	Unit	Code	Unit	Code	Unit
0	L/S	3	M3/S	6	T/S	9	GPS
1	L/M	4	M3/M	7	T/M	10	GPM
2	L/H	5	M3/H	8	T/H	11	GPH

● Cumulative flow unit

Table 4 ( It is suit for B type and 511 type electromagnetic flowmeter converter)

Code	0	1	2	3
Cumulative unit	L	M3	T	USG

Table 5 ( It is suit for C type electromagnetic flowmeter converter)

Code	0	1	2	3	4	5
Cumulative unit	L	L	L	M3	M3	M3
Code	6	7	8	9	10	11
Cumulative unit	T	T	T	USG	USG	USG

● Alarm

Upper limit alarm, lower limit alarm, empty pipe alarm, system alarm:

0 ----- No alarm; 1----- Alarm

## 6. Communication data analysis

Instantaneous flow, instantaneous velocity, flow percentage, fluid conductivity ratio, decimal part of the cumulative positive and negative value, format conversion of float, integer part of the cumulative positive and negative value, transmission of long.

### 1) Read instantaneous flow

Master sends command (hexadecimal number)

01	04	10	10	00	02	74	CE
Device address	Function code	Register high address	Register high address	Register high length	Register low length	CRC high	CRC low

Data that master receives

01	04	04	C4	1C	60	00	2F	72
Device address	Function code	Data length	4 bytes float (instantaneous flow)				CRC high	CRC low

Float:            C4            1C            60            00  
 1100 0100      0001 1100      0110 0000      0000 0000  
 float byte 1    float byte 2      float byte 3    float byte 4

S=1: if mantissa symbol is 1, it is a negative.

E=10001000: Exponent is 136

M=001 1100    0110 0000    0000 0000, The mantissa is :

$$V = (-1)^1 2^{(136-127)} \left(1 + \frac{1}{8} + \frac{1}{16} + \frac{1}{32} + \frac{1}{512} + \frac{1}{1024}\right)$$

$$= -625.5$$

**2) Read instantaneous velocity**

Master sends command (hexadecimal number)

01	04	10	12	00	02	D5	0E
Device address	Function code	Register high address	Register high address	Register high length	Register low length	CRC high	CRC low

Data that master receives

01	04	04	C1	B0	80	00	A6	5F
Device address	Function code	Data length	4 bytes float (instantaneous velocity)				CRC high	CRC low

Float:            C1            B0            80            00  
 1100 0001      1011 0000      1111 1000      0000 0000  
 S=1

E= 10000011

M= 011 0000 1111 1000 0000 0000

$$V = (-1)^1 2^{(131-127)} \left(1 + \frac{1}{4} + \frac{1}{8} + \frac{1}{256}\right)$$

$$= -22.0625$$

### 3) Read cumulative flow

To express the 9 bits cumulative value of electromagnetic flowmeter totally, integer part and decimal part of cumulative flow are expressed respectively. The integer part uses long variable and the decimal uses float variable.

Cumulative flow is 1578m<sup>3</sup>

Master sends command to collect the integer value of cumulative flow

01	04	10	18	00	02	F5	0C
Device address	Function code	Register high address	Register high address	Register high length	Register low length	CRC high	CRC low

Data that master receives

01	04	04	00	00	70	71	1E	60
Device address	Function code	Data length	4 bytes float (integer value of cumulative flow)				CRC high	CRC low

Integer value of cumulative flow is 28785

Master sends command to collect the decimal value of cumulative flow

01	04	10	1A	00	02	54	CC
Device address	Function code	Register high address	Register high address	Register high length	Register low length	CRC high	CRC low

Data that master receives

01	04	04	3F	00	00	00	3B	90
Device address	Function code	Data length	4 bytes float (decimal value of cumulative flow)				CRC high	CRC low

Float:           3F               00               00               00  
           0011 1111       0000 0000       0000 0000       0000 0000  
           S=0  
           E= 0111111       126  
           M= 000 0000 0000 0000 0000 0000

$$V = (-1)^1 2^{(126-127)} = 0.5$$

**4) Read instantaneous flow unit**

Master sends 8 bytes command to read instantaneous flow unit

01	04	10	20	00	01	34	C0
Device address	Function code	Register high address	Register high address	Register high length	Register low length	CRC high	CRC low

7 bytes data that master receives from slave

01	04	02	00	05	79	33
Device address	Function code	Data length	2 bytes integer (instantaneous flow unit)		CRC high	CRC low

Flow unit is  $M^3/H$  from table-3.

**5) Read the unit of the total amount of flow**

Master sends 8 bytes command to read instantaneous flow unit

01	04	10	21	00	01	65	00
Device address	Function code	Register high address	Register high address	Register high length	Register low length	CRC high	CRC low

7 bytes data that master receives from slave

01	04	02	00	01	78	F0
Device address	Function code	Data length	2 bytes integer (cumulative flow unit)		CRC high	CRC low

Flow unit of B type and 511 type is  $M^3$  from table-4.

Flow unit of C type is L from table-5.

**6) Read alarm status**

Master sends 8 bytes command to read instantaneous flow unit

01	04	10	24	00	01	75	01
Device address	Function code	Register high address	Register high address	Register high length	Register low length	CRC high	CRC low

7 bytes data that master receives from slave

01	04	02	00	01	78	F0
Device address	Function code	Data length	2 bytes integer (alarm)		CRC high	CRC low

Empty pipe is in alarm status if status is 1.

Other alarm status is the same and so on.

## 7. Application examples

### 1) MODBUS example program with C

#### ● CRC16 algorithm:

```
INT16U CRC16(INT8U *puchMsg, INT16U usDataLen)
{
    INT8U uchCRCHi = 0xFF;      /* High CRC bytes initialization */
    INT8U uchCRCLo = 0xFF;      /* Low CRC bytes initialization */
    INT8U uIndex;                /* CRC index of the cycle */
    while (usDataLen--)          /* Message transmission buffer */
    {
        uIndex = uchCRCHi ^ *puchMsg++; /* calculate CRC */
        uchCRCHi = uchCRCLo ^ uchCRCHi[uIndex];
        uchCRCLo = uchCRCLo[uIndex];
    }
    return (uchCRCHi << 8 | uchCRCLo);
}
```

#### ● Program of sending commands

This example is on the basis of that the core CPU is Mag64

```
void Read_InPut(INT8U Addr,INT16U Start,INT16U Len)
{
    INT16U CRC;
    SendBuffer_485[0]=Addr;          //Device address
    SendBuffer_485[1]=0x04;          //MODBUS function code
    SendBuffer_485[2]=Start/256;      //Start is register address
    SendBuffer_485[3]=Start%256;
    SendBuffer_485[4]=Len/256;        //Len is reading register length
    SendBuffer_485[5]=Len%256;
    CRC=CRC16(SendBuffer_485,6);
    SendBuffer_485[6]=CRC/256;        //CRC high bits
    SendBuffer_485[7]=CRC%256;        //CRC low bits
    R485_OUT;                          //Enable RS485 to send data
    SendLen_485=8;
}
```

```

    SendNum_485=0;
    CloseINT0();           //Close interrupt of serial port receiving data
    UCSR0B |= BIT(UDRIE0); // Open interrupt of serial port sending data
}

```

- Analysis of the data return (take instantaneous flow as an example only)

Using serial port interrupt when receiving data. ReceivedBuffer\_485 is received data group. ReceivedNum\_485 is received data length. ReceivedFlag\_485 is data symbol when it has received data. Function *float Datasum(INT8U BYTE1, INT8U BYTE2, INT8U BYTE3, INT8U BYTE4)* changes 4 bytes float into a float.

```

float Datasum(INT8U FloatByte1, INT8U FloatByte2, INT8U FloatByte3, INT8U FloatByte4)
{
    float aa;
    union IntTOFP
    {
        FP32      F32;
        INT8U     T8[4];
    };
    union IntTOFP aa;
    aa.T8[0] = FloatByte1;
    aa.T8[1] = FloatByte2;
    aa.T8[2] = FloatByte3;
    aa.T8[3] = FloatByte4;
    return aa;
}

void Read_Lmag(INT8U Ad)
{
    INT8U  i,j;
    INT8U  Num1[10],BIT;
    INT16U CRC1,CRC2;
    FP32   Flow;           //aaa is instantaneous flow value
    ReceivedFlag_485=1;
    Open_Time1_Ms5(20);
    Read_InPut(Ad,0x1010,2); //Send device address, register address and register length
    while(ReceivedFlag_485); //Waiting receiving interrupt
    if((ReceivedNum_485==9)&&(ReceivedBuffer_485[0]==Ad)) // Judge whether it is right
    {
        CRC1=CRC16(ReceivedBuffer_485,7);
        CRC2=ReceivedBuffer_485[7]*256+ReceivedBuffer_485[8];
        if(CRC1==CRC2)
        { // Change data into float
            Flow = Datasum(ReceivedBuffer_485[6], ReceivedBuffer_485[5],
                ReceivedBuffer_485[4],ReceivedBuffer_485[3]); } }
}

```

## 2) Communication example of MODBUS debugging software MODUBS poll

Slave address is 1. Band rate is 9600. Read all of the real-time data. The setting method is shown as follows.

As tabe-2 shows that start register address is 4113. Register number is 22.

- i. Set collecting command including device address(1), MODBUS function code(04), register address(4113), register length(2), sample interval(1000).

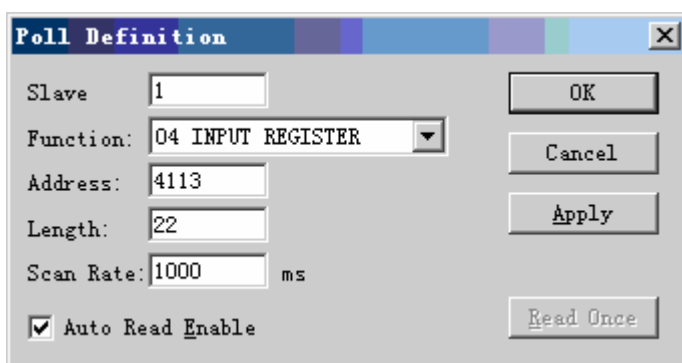

- ii. Set serial port data

On the basis of L-mag electromagnetic flow meter serial port format( 1 start bit, 8 data bits, 1 stop bit, no parity bit), the detailed setting method is shown as follows.

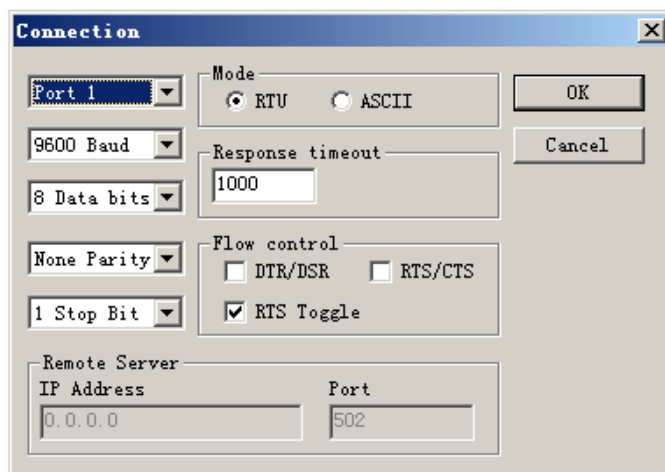

iii. Set data presentation format

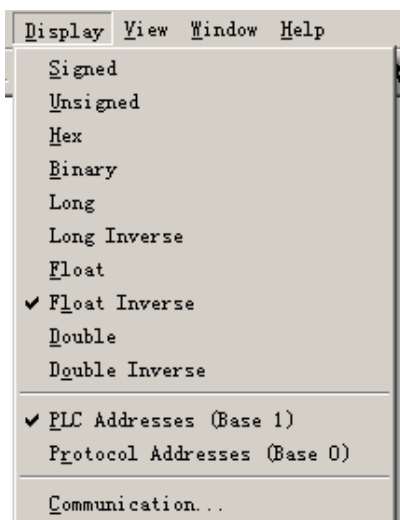

iv. Successful communication interface

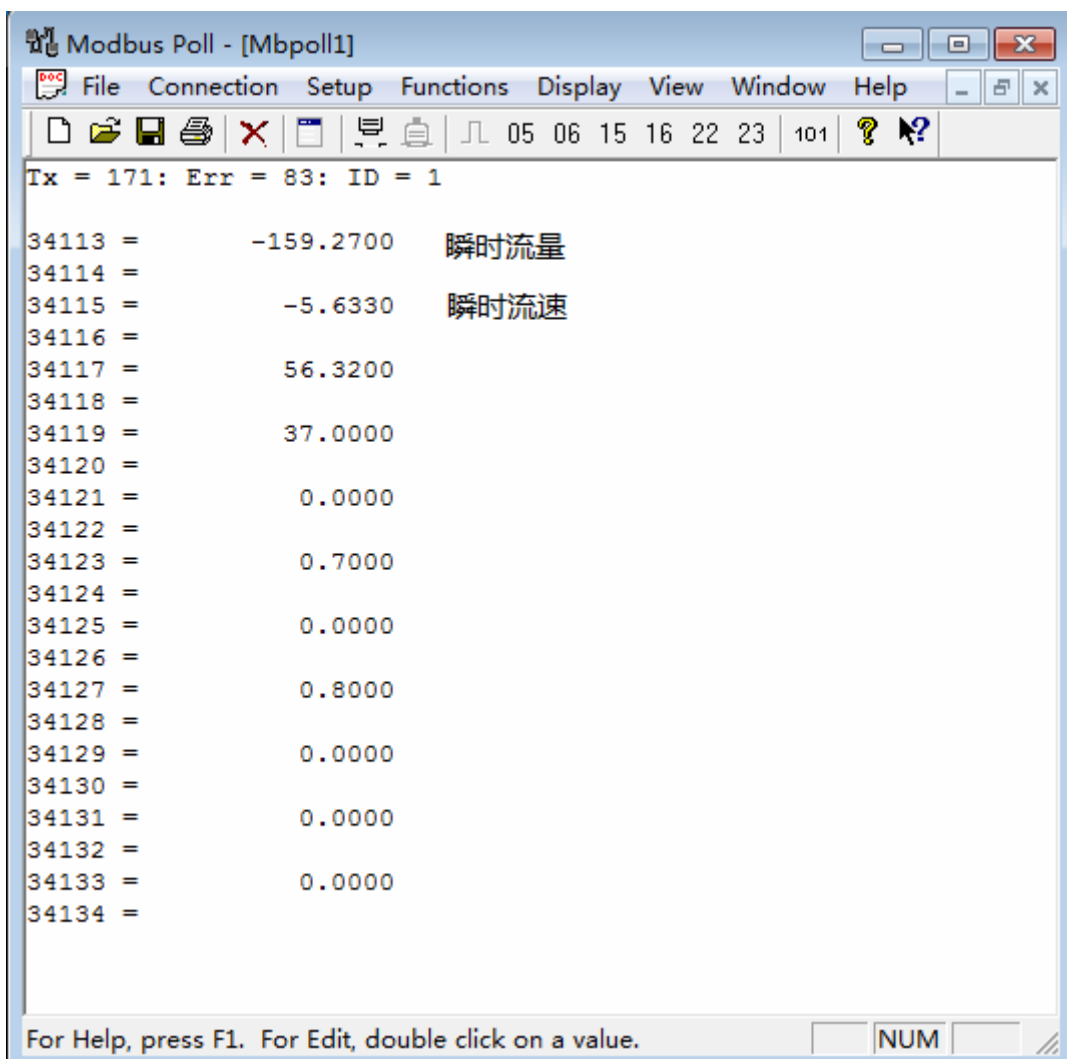



### 3) Communication example of MODBUS debugging software modscan32

Slave address is 1. Band rate is 9600. Read all of the real-time data. The setting method is shown as follows.

As tabe-2 shows that start register address is 4113. Register number is 22.

- i. Set collecting command including device address(1), MODBUS function code(04), register address(4113), register length(2), sample interval(1000).

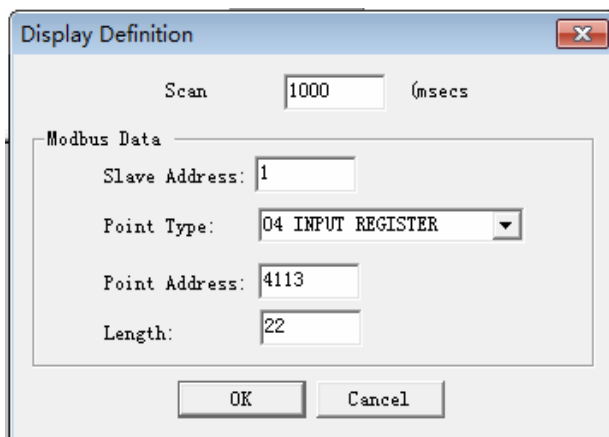

- ii. Set serial port data

On the basis of L-mag electromagnetic flowmeter serial port format( 1 start bit, 8 data bits, 1 stop bit, no parity bit), the detailed setting method is shown as follows.

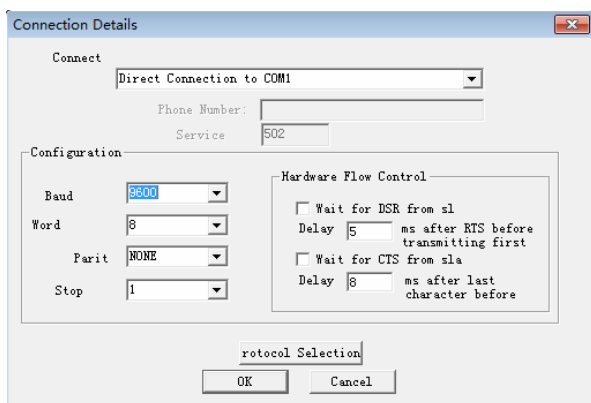

- iii. Set data's presentation format

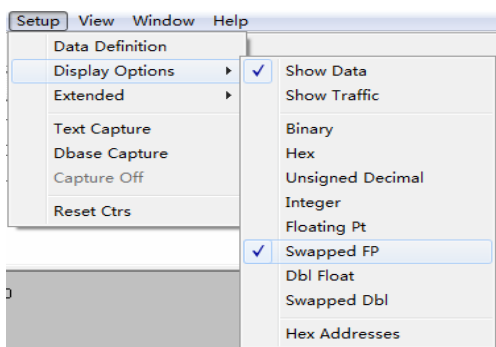

iv. Successful communication interface

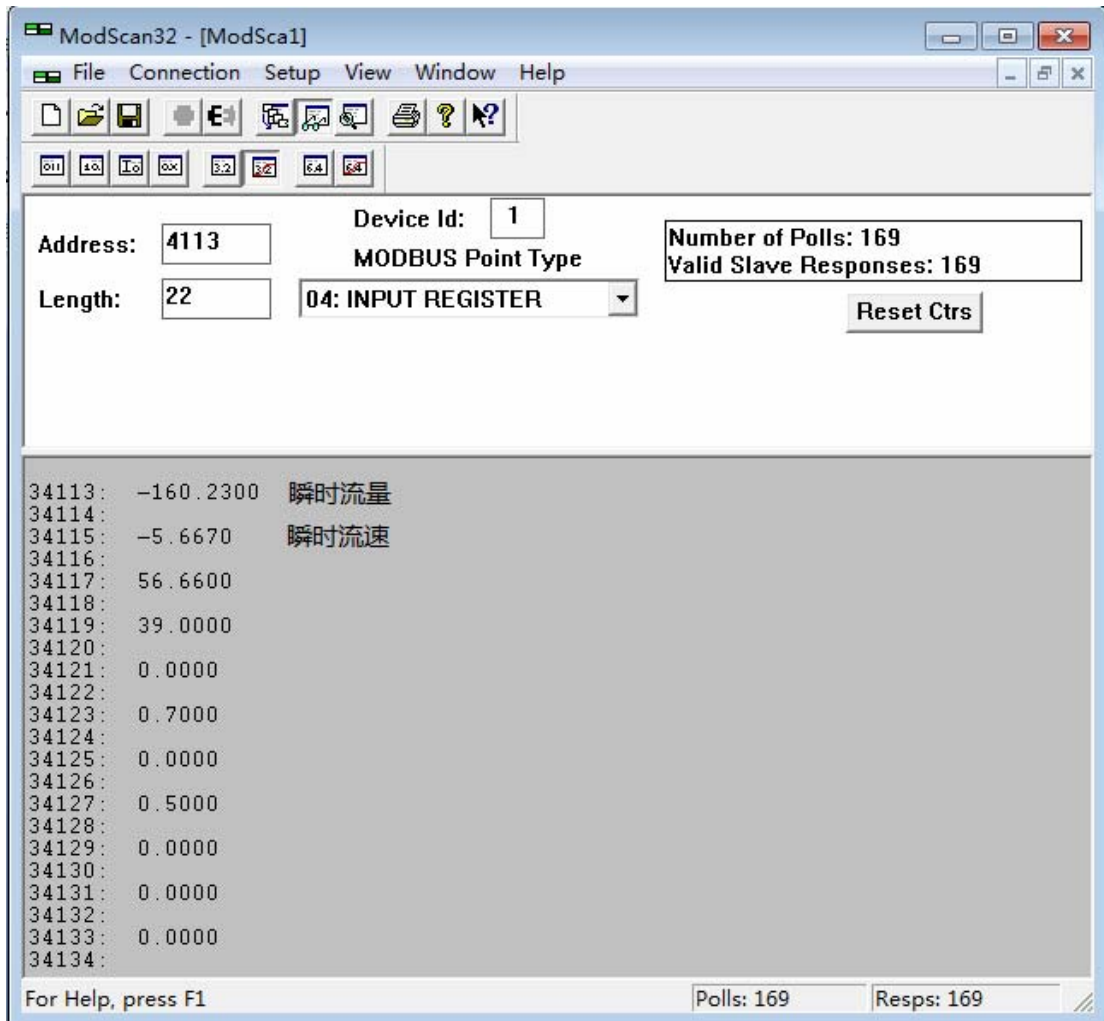

#### 4) Communication example of “KingView 6.53”

The 1st step:

Build kingview project

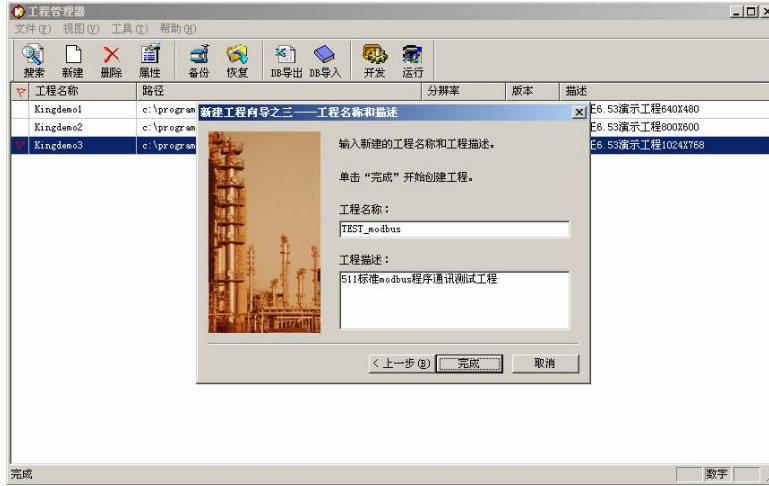

The 2<sup>nd</sup> step:

Add standard Modbus device, KingView device list-PLC-Modicon-modbus (RTU).

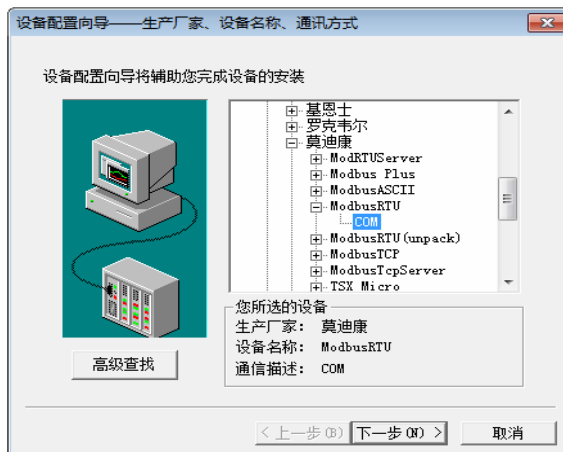

Set device address as the electromagnetic flowmeter’s address. Take address 1 as an example



The 3rd step: Double click device's COM to set serial parameters



L-mag electromagnetic flowmeter's serial port parameters: Baud rate is the same as electromagnetic flowmeter's, 1 start bit, 8 data bits, 1 stop bit, no parity bit. Take baud rate 9600 for an example.

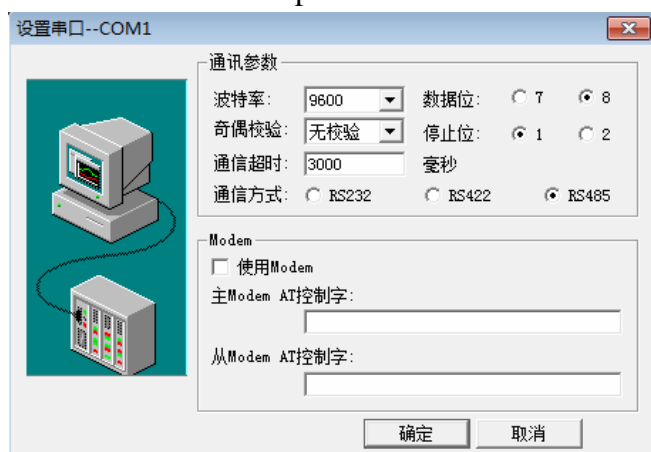

The 4<sup>th</sup> step: Click data dictionary to add L-mag data variable

According to KingView drivers illustration: Modicon-modbus (RTU) variable name, register address and data format. See table as follows:

Variable name	Register value	Data format	Frequency	property
Instantaneous flow	34113	Float	500	Read only
Instantaneous flow velocity	34115	Float	500	Read only
Flow percentage	34117	Float	500	Read only
Fluid conductivity ratio	34119	Float	500	Read only
Integer part of positive cumulative value	34121	Long	500	Read only
Decimal part of positive cumulative value	34123	Float	500	Read only
Integer part of reverse cumulative value	34125	Long	500	Read only
Decimal part of reverse cumulative value	34127	Float	500	Read only
Data transition register	SwapL0	Byte	0	Write only

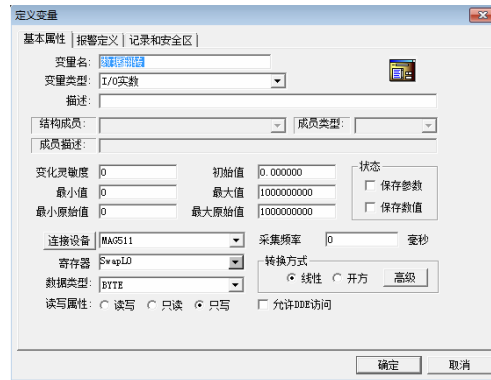
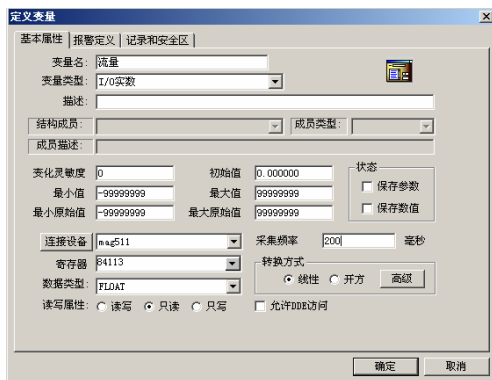

**Note: For the data storage format of electromagnetic flowmeter, When adding variable to KingView, the data transition register must be added. Or communication data will present abnormally.**

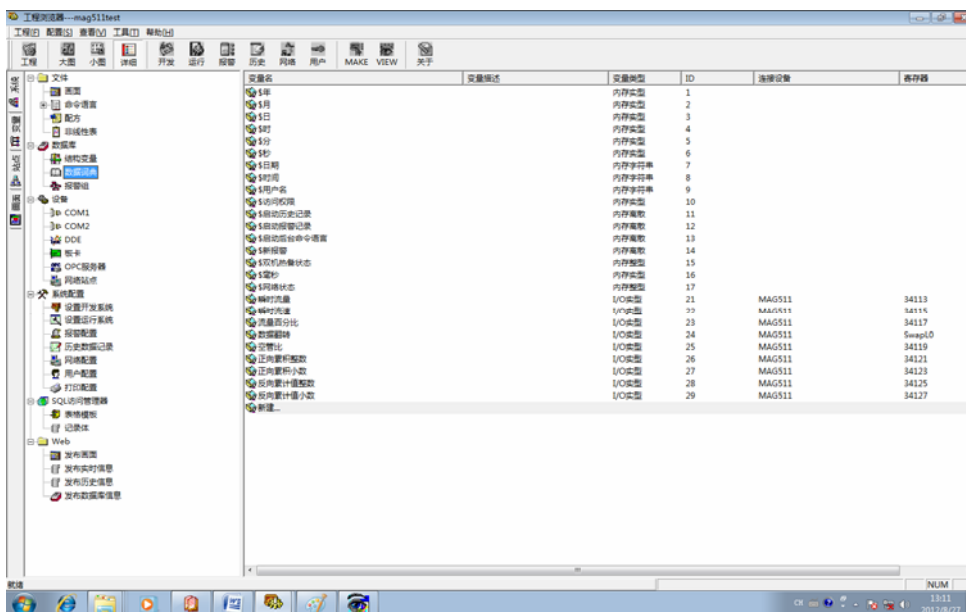

**数据寄存器对应的功能码**

功能码用十六进制数表示。

寄存器	读的功能码	写的功能码	说明
0	0x01	0x05	逻辑线圈
1	0x02		输入位寄存器
3	0x04		输入寄存器
4	0x03	0x06	保持寄存器
7	0x14	0x15	配置寄存器 (General Reference)
8	0x04		输入寄存器
9	0x03	0x10	保持寄存器
FMC		0x0F	强制多线圈状态

The 5<sup>th</sup> step:  
Create the window and link the variable.



The 6<sup>th</sup> step:  
Save modification and run project

Flow Volume	-116.51999
Flow Velocity	-4.121
Percentage	41.20
Ratio of Emptiness	8
Integer part of the positive cumulative	145570342
Decimal part of the positive cumulative	0.000
Integer part of the negative cumulative	488903076
Decimal part of the negative cumulative	0.000

### 5) Communication example of “力控 6.1”

The 1<sup>st</sup> step:

Build a project

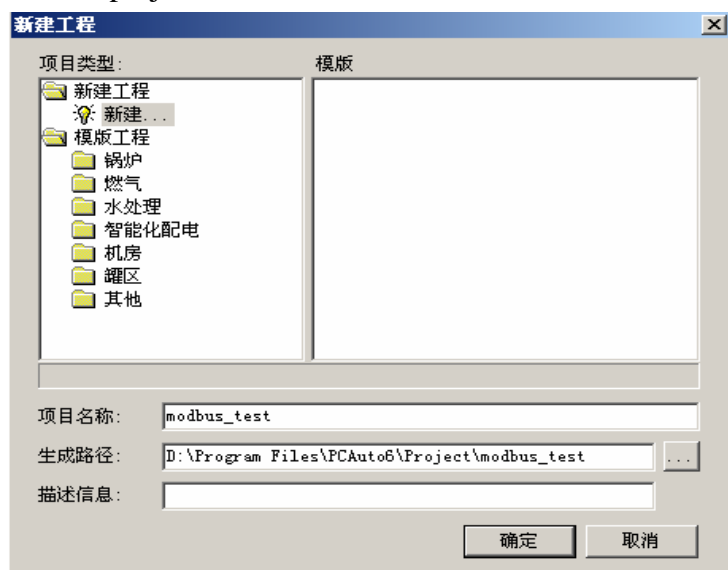

The 2<sup>nd</sup> step:

IO port device configuration chooses IO device-Modbus- standard Modbus-Modbus (RTU serial port)



Choose serial port



Set displaying data format



The 3<sup>rd</sup> step:

Database configuration



Set the data format and address offset

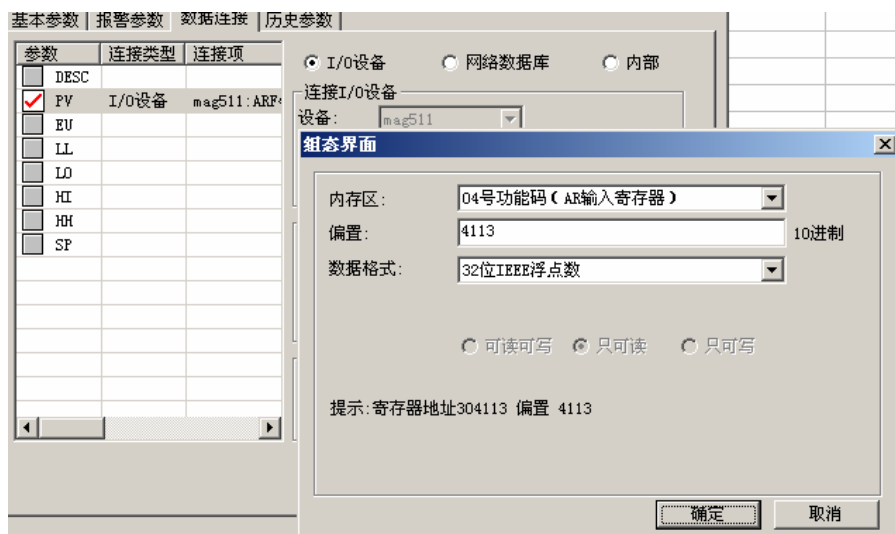



Data example

	NAME 【点名】	DESC 【说明】	%IOLINK 【I/O连接】	%HIS 【历史参数】
1	ssl1	瞬时流量	PV=mag511:ARF4113	
2	ssl5	瞬时流速	PV=mag511:ARF4115	
3	llbfb	流量百分比	PV=mag511:ARF4117	
4	ltddb	流体电导比	PV=mag511:ARF4119	
5	zxljzsf	正向累积值整数部分	PV=mag511:ARL4121	
6	zxljzsf	正向累积值小数部分	PV=mag511:ARF4123	
7	fxljzsf	反向累积值整数部分	PV=mag511:ARL4125	
8	fxljzsf	反向累积值小数部分	PV=mag511:ARF4127	

The 4<sup>th</sup> step:

Create the window and link the variable

Flow Volume	#####.#####
Flow Velocity	##.###
Percentage	###.##
Ratio of Emptiness	#####
Integer part of the positive cumulative	#####
Decimal part of the positive cumulative	#.###
Integer part of the negative cumulative	#####
Decimal part of the negative cumulative	#.###

The 5<sup>th</sup> step:

Run the project

Flow Volume	-116.51999
Flow Velocity	-4.121
Percentage	41.20
Ratio of Emptiness	8
Integer part of the positive cumulative	145570342
Decimal part of the positive cumulative	0.000
Integer part of the negative cumulative	488903076
Decimal part of the negative cumulative	0.000

### 6) MCGS communication example

Using guide:

The 1<sup>st</sup> step:

Create a project and it will appear window as follows. Then choose “设备窗口”, double click it.

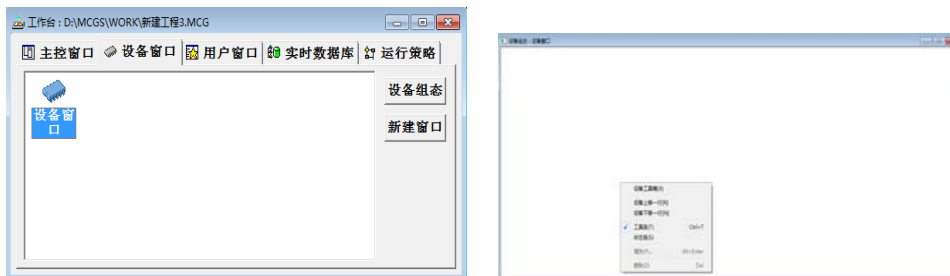

Choose “设备工具箱”. Click “设备管理” and then add “通用串口父设备” and “标准 MODBUSRTU 设备” to project.

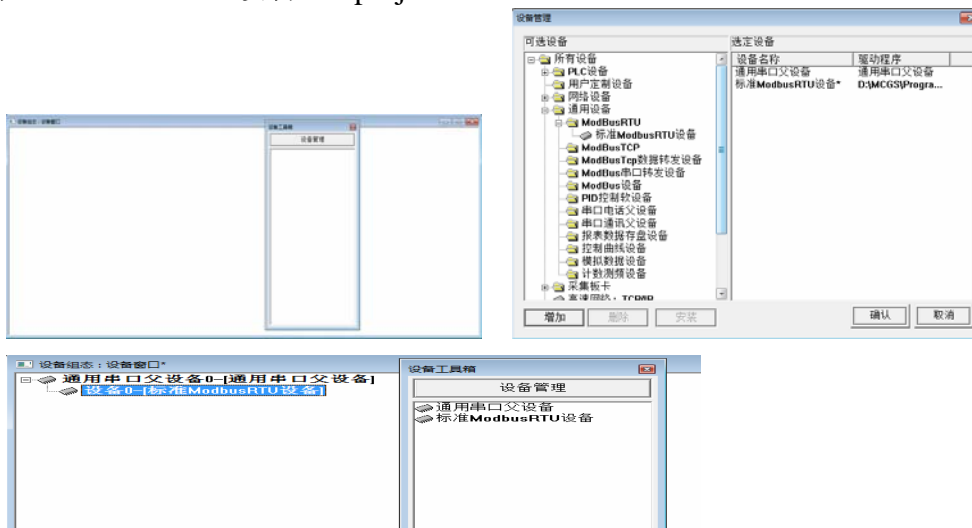

Choose “通用串口父设备 0” and “设备 0”.

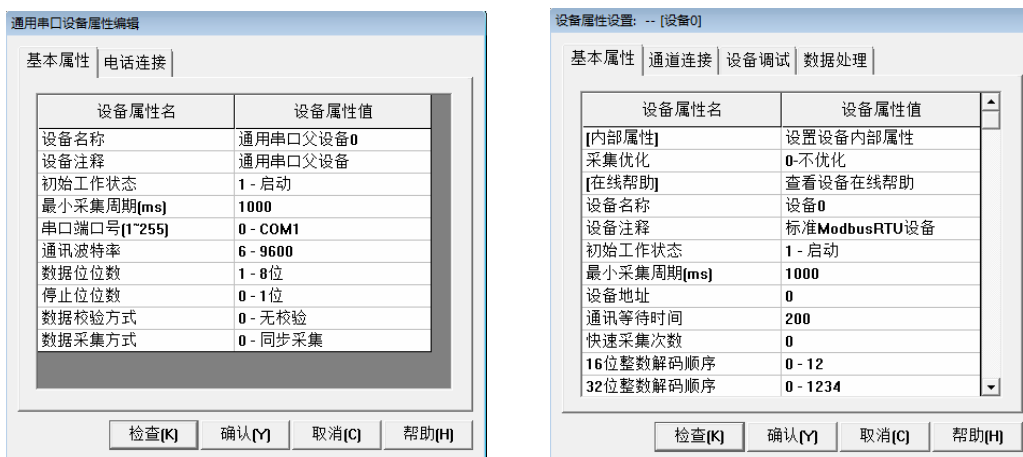

Device's address is 1. 32 bits float's decoding order is 0-1234. Parity format is 0-LH [low bytes, high bytes]. Choose “设置内部属性”.

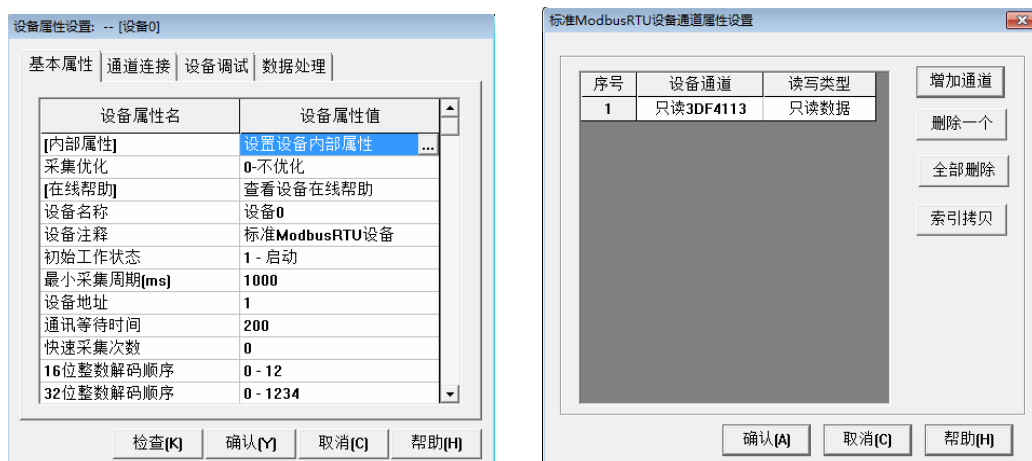

Click “添加通道”. Then appear:

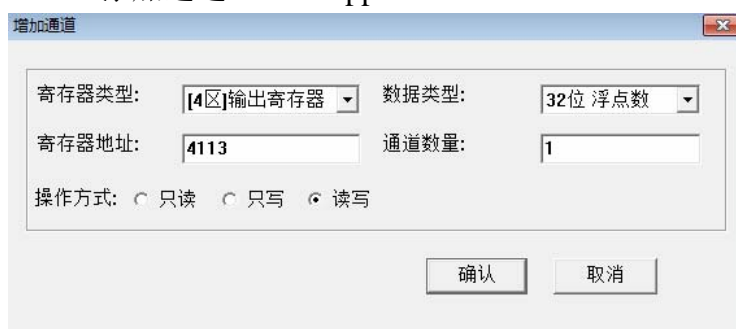

Register address	Data format	Channel number	Register definition
4113	32 bits float	1	Flow percentage
4115	32 bits float	1	Fluid conductivity ratio
4117	32 bits float	1	Integer part of positive cumulative value
4119	32 bits float	1	Decimal part of positive cumulative value
4121	32 bits unsigned binary number	1	Integer part of reverse cumulative value
4123	32 bits float	1	Decimal part of reverse cumulative value
4125	32 bits unsigned binary number	1	Flow percentage
4127	32 bits float	1	Fluid conductivity ratio

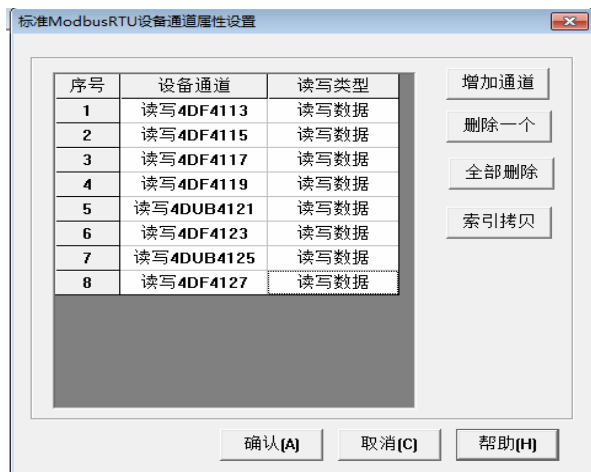

Choose “通道连接”



Choose “设备调试”

